

Operating Temperature Range: -40 to +125°C  
Storage Temperature Range: -50 to +150°C

◆STANDARD RATINGS

Part Number	Previous Part Number (Just for your reference)	Max. Allowable Voltage		Maximum applicable voltage for a short period	Max. Energy	Max. Clamping Voltage		Varistor Voltage V <sub>1mA</sub>
		Continuous		5 minutes		(A)	(V)	
		AC (Vrms)	DC (V)	DC (V)				
TND09H-220KB00AAA0	TNR9H220K	12	16	24	5	2	43	22 (20~24)
TND09H-270KB00AAA0	TNR9H270K	15	19	29			53	27 (24~30)
TND09H-330KB00AAA0	TNR9H330K	18	24	36			65	33 (30~36)
TND09H-390KB00AAA0	TNR9H390K	22	28	42			77	39 (35~43)
TND09H-470KB00AAA0	TNR9H470K	26	34	50			93	47 (42~52)
TND12H-220KB00AAA0	TNR12H220K	12	16	24	10	5	43	22 (20~24)
TND12H-270KB00AAA0	TNR12H270K	15	19	29			53	27 (24~30)
TND12H-330KB00AAA0	TNR12H330K	18	24	36			65	33 (30~36)
TND12H-390KB00AAA0	TNR12H390K	22	28	42			77	39 (35~43)
TND12H-470KB00AAA0	TNR12H470K	26	34	50			93	47 (42~52)
TND15H-220KB00AAA0	TNR15H220K	12	16	24	20	10	43	22 (20~24)
TND15H-270KB00AAA0	TNR15H270K	15	19	29			53	27 (24~30)
TND15H-330KB00AAA0	TNR15H330K	18	24	36			65	33 (30~36)
TND15H-390KB00AAA0	TNR15H390K	22	28	42			77	39 (35~43)
TND15H-470KB00AAA0	TNR15H470K	26	34	50			93	47 (42~52)
TND23H-220KB00AAA0	TNR23H220K	12	16	24	40	25	43	22 (20~24)
TND23H-270KB00AAA0	TNR23H270K	15	19	29			53	27 (24~30)
TND23H-330KB00AAA0	TNR23H330K	18	24	36			65	33 (30~36)
TND23H-390KB00AAA0	TNR23H390K	22	28	42			77	39 (35~43)
TND23H-470KB00AAA0	TNR23H470K	26	34	50			93	47 (42~52)

◆DIMENSIONS [mm]

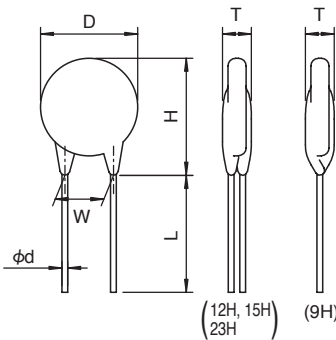

Type	D Max.	H Max.	T Max.	W ±1.0	L Min.	φd ±0.05
9H	10.0	13.0	5.0	5.0	25.0	0.6
12H	13.5	16.5	5.0	7.5	25.0	0.8
15H	16.5	19.0	5.0	7.5	25.0	0.8
23H	24.0	27.0	5.0	10.0	25.0	0.8

◆MARKING

EX)

●9H

●12H~23H

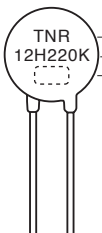
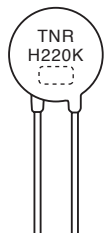

Trade mark  
Size, Ratings  
Lot. No.

H Series

◆V-I CURVE

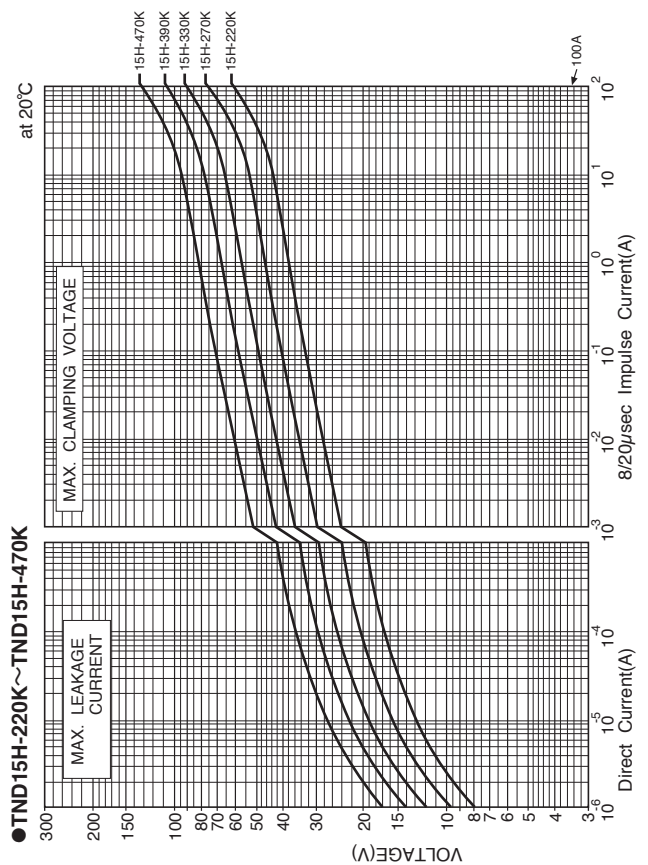
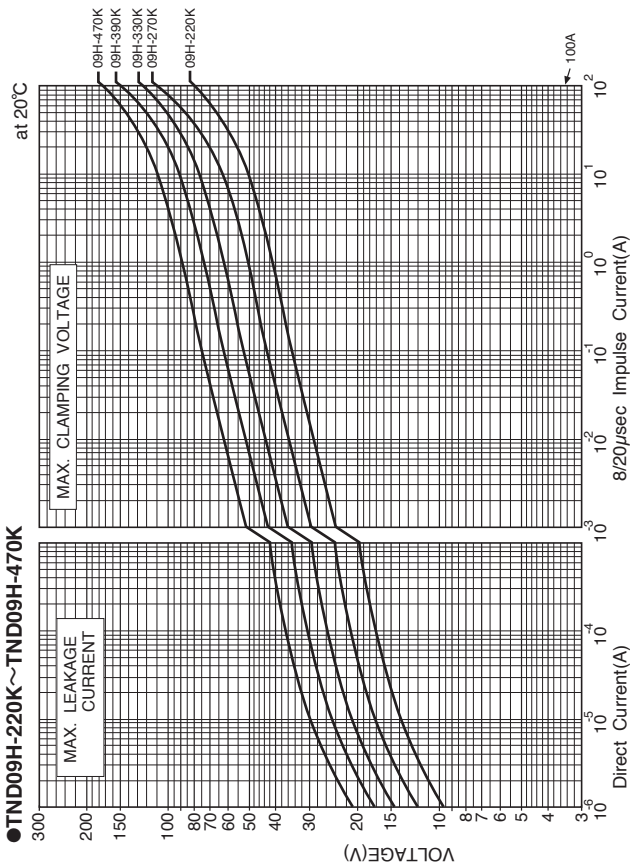
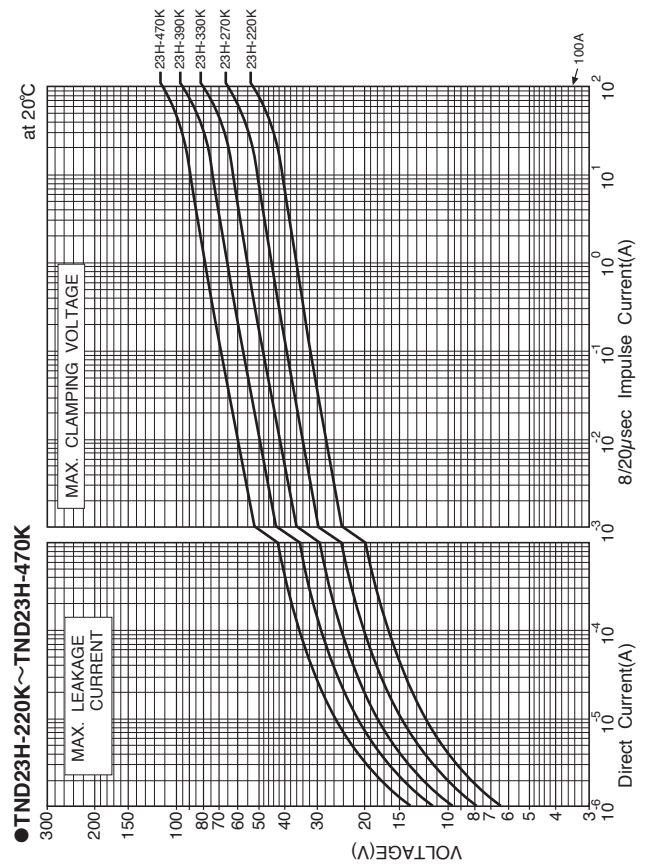
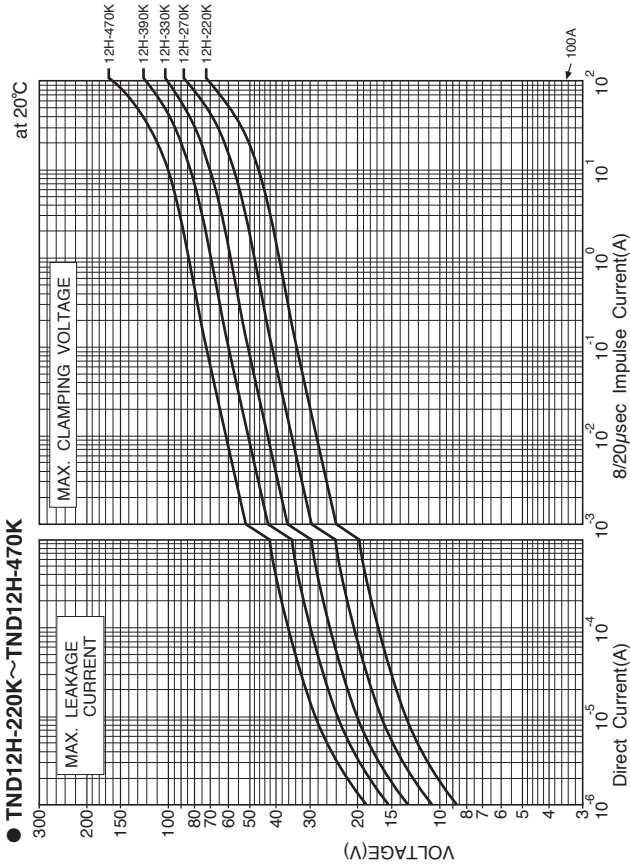

**◆GENERAL SPECIFICATIONS**

 Operating Temperature Range: -40 to +125°C  
 Storage Temperature Range: -50 to +150°C

Item	Test Conditions	Specifications
Standard Test Condition	20±15°C, 85%RH Max.	
Varistor Voltage	The voltage between the two terminals measured at 1mA DC is called Varistor Voltage. The measurement shall be made as fast as possible to avoid heat affection.	Satisfy the specification.
Maximum Allowable Voltage	Maximum continuous sinusoidal RMS voltage or Maximum continuous DC voltage which may be applied.	Refer to Ratings.
Maximum applicable voltage for a short period (5 minutes)	Maximum DC voltage to be applied for only 5 minutes.	Refer to Ratings.
Maximum Clamping Voltage	The maximum voltage between the terminals, measured standard impulse current (8/20 μs).	Satisfy the specification.
Maximum Energy	Maximum energy within the ±10% varistor voltage change when 1 impulse 20 ms long is applied.	Satisfy the specification.
Temperature Coefficient	$\frac{V_{1mA \text{ at } 85^\circ\text{C}} - V_{1mA \text{ at } 25^\circ\text{C}}}{V_{1mA \text{ at } 25^\circ\text{C}}} \times \frac{1}{60} \times 100 (\%/^\circ\text{C})$	Within ±0.05 % / °C

**◆MECHANICAL CHARACTERISTICS**

Item	Test Conditions	Specifications		
Terminal Pull Strength	After gradually applying the force keeping the unit fixed for 10±1 sec. in axial direction, the damage of the terminals shall be visually examined. $\frac{\text{Lead diameter}}{\phi 0.6\text{mm. } \phi 0.8\text{mm}} \quad \frac{\text{Force}}{10 \text{ N}}$	$\Delta V_{1mA} / V_{1mA} \leq \pm 5\%$ No remarkable damage		
Terminal Bending Strength	The unit shall be secured with its terminal kept vertical and the weight specified below be applied in the axial direction. The terminal shall gradually be bend by 90° in one direction then 90° in the opposite direction, and again back to original position. The damage of the terminal shall be visually examined. $\frac{\text{Lead diameter}}{\phi 0.6\text{mm. } \phi 0.8\text{mm}} \quad \frac{\text{Force}}{5 \text{ N}}$	No remarkable damage		
Vibration	After repeatedly applying a single harmonic vibration (amplitude : 0.75mm) double amplitude : 1.5mm with 1 minute vibration frequency cycle (10Hz → 500Hz → 10Hz) to each three perpendicular directions for 2 hours. Total 6 hours. The devices shall be visually examined.	$\Delta V_{1mA} / V_{1mA} \leq \pm 5\%$ No remarkable damage		
Resistance to Soldering Heat	Each lead shall be dipped into a solder bath having a temperature of 350±10°C to a point 2.0 to 2.5 mm from the body of the unit, be held there for 3 <sub>0</sub> <sup>+</sup> sec and then be stored at room temperature for 1 to 2 hours. The ΔV <sub>1mA</sub> and mechanical damage shall be examined. or Each lead shall be dipped into a solder bath having a temperature of 260±10°C to a point 2.0 to 2.5 mm from the body of the unit, be held there for 10±1 sec and then be stored at room temperature for 1 to 2 hours. The ΔV <sub>1mA</sub> and mechanical damage shall be examined.	$\Delta V_{1mA} / V_{1mA} \leq \pm 5\%$ No remarkable damage		
Solderability	Each lead shall be dipped into a methanol solution (about 25%) of rosin for 5 to 10 sec. Then each lead shall be dipped into a solder.	At least, 95% of the leads shall be covered with solder uniformly.		
	Solder		Pb free (Sn-3.0Ag-0.5Cu)	Eutectic (Sn/Pb)
	Solder Temp.		245±5°C	235±5°C
	Dipping Time		2±0.5sec.	
	Dipping Depth	1.5 to 2.0mm (from the body)		



## H Series

### ◆ENVIRONMENTAL CHARACTERISTICS

Item	Test Conditions	Specifications
<b>High Temperature Storage (Dry heat)</b>	The specimen shall be subjected 150±2°C for 1000±12 hours without load.	$\Delta V1mA/V1mA \leq \pm 10\%$
<b>Low Temperature Storage</b>	The specimen shall be subjected -40±2°C for 1000±12 hours without load.	$\Delta V1mA/V1mA \leq \pm 5\%$
<b>Damp heat (Humidity)</b>	The specimen shall be subjected to 60±2°C, 90 to 95%RH for 1000±12 hours without load.	$\Delta V1mA/V1mA \leq \pm 10\%$
<b>Temperature Cycle</b>	The temperature cycle shown below shall be repeated 50 cycles. -40±3°C, 30 minutes ⇔ +150±2°C, 30 minutes	$\Delta V1mA/V1mA \leq \pm 10\%$ No remarkable damage
<b>High Temperature Operating</b>	The specimen shall be subjected to 125±2°C with the maximum allowable voltage for 1000±12 hours.	$\Delta V1mA/V1mA \leq \pm 20\%$
<b>Damp heat Operating</b>	The specimen shall be subjected to 60±2°C, 90 to 95%RH with the maximum allowable voltage for 1000±12 hours.	$\Delta V1mA/V1mA \leq \pm 10\%$

Varistor voltage change of forward direction shall be measured in the test of unipolar surge life and DC load life.

Varistor voltage change is measured after stored at Standard Test Conditions for 1 to 2 hours.

Note : For 42V battery line, please contact our sales office.